

# (ENG) Operating and installation instructions

## I. General information

### General information

The upholstered furniture is equipped with an electric relaxation function, which provides cosy relaxation and functional comfort in addition to a comfortable position. This product has been designed and manufactured for the sole purpose of use as described in this documentation. Use for any other purpose not specified here may adversely affect the technical condition and operation of the product and is a potential source of danger.

The furniture is designed for indoor use and storage, and must not be used on the balcony or in the garden, or in other areas where conditions differ from normal domestic conditions. Furniture and especially all electrical components should be protected from environmental influences. Do not expose the device to sunlight, rain, snow, dust, or excessive moisture, as penetrating water and dirt increase the risk of electric shock!

### Electric relaxation function

Furniture with a relaxation function that has an electric mechanism is extremely comfortable, as body pressure is not required to achieve the desired inclination. The electric mechanism used makes it possible to smoothly activate the relaxation function by using the buttons on the control panel. Furniture with a relaxation function with an electric mechanism should be positioned close to a power source, which is necessary for the mechanism to operate.

## II. Electrical function diagram

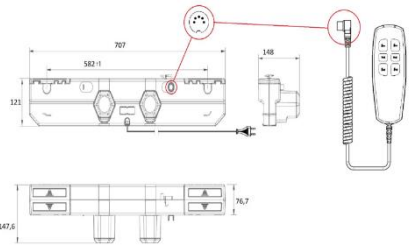



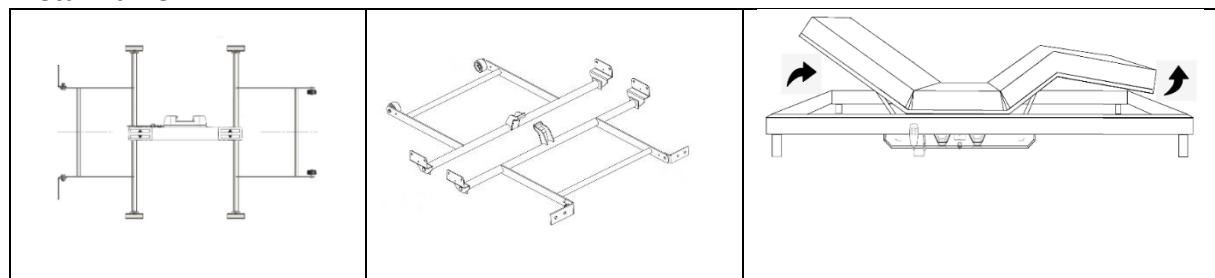



<p>Producent – Germany Motion ACTUATOR Type: TWINMOT T3-ECO Load capacity: 2 x 6500N Adjustment speed: max 4,3mm/s. Duty cycle CE: 2 min ON / 18 min OFF IP20 Ambient temperature: +10°C bis +40°C Power supply: 110 – 240 V Emergency lowering: 9V alk. batt.</p>	
--	--

### Metal frame



### III. Safety instruktion

#### A. Warning and information signs

	Information
	Warning - Indicates a warning to users of potential dangers to themselves and others. All hazard warnings are preceded by the Warning symbol and the following terms: warning, danger. Warning - All safety warnings specify in detail the danger/warning that exists and indicate how to reduce the risk of injury, damage, and electrical shock from improper use of the equipment. Scrupulously observe the instructions below. Danger - Indicates a dangerous situation, the possible occurrence of which leads to serious injury.
	Danger
	Do not sit on the item
	Keep hands clear, moving parts
	This symbol indicates for indoor use only (IEC 60417-5957)
	Protection class II means that the equipment has basic insulation and additional means of protection in the form of reinforced or double insulation (IEC 60417-5172)
	Protection class III means that the device is supplied with safe, reduced voltage (IEC 60417-5180)

#### B. Safety information



For safety reasons and to ensure correct operation, please read this document before installing and using it for the first time, paying particular attention to the instructions and warnings.

This manual should be kept near the device. It must be ensured that the instructions can be consulted at any time by persons who are required to perform operations on the device.

Please keep the instructions and ensure that it remains with the furniture if it is moved or sold, so that every user has access to information on use and safety throughout the usage period.

The furniture is not intended for commercial/public use.

Any use not in accordance with the description in this manual is considered inappropriate and the manufacturer shall not be liable for claims or damages arising from such conduct. Correct use also includes respecting the conditions laid down by the manufacturer for installation, connection, use, handling/transport, maintenance and cleaning, and repair.

In order to prevent accidents - all rules for safe use and the avoidance of dangers must be observed.

Any changes to the design of the device made by the user may affect the safety of use and relieve the manufacturer of any liability for claims or damage resulting from such action.

Although the manufacturer is responsible for the design of the equipment eliminating the danger, some elements of risk during operation are unavoidable. Residual risks arise from erroneous operating behaviour.

The greatest danger is in performing the following prohibited activities:

- using the appliance at times when other people (especially small children) and pets are in the vicinity;
- use of the device for purposes other than those described in the user manual;
- use of the device by persons not acquainted with the instructions for use;

If the recommendations provided in the operating instructions are adhered to, the residual risk when using the device can be eliminated. There are risks if the above recommendations are not followed.



Danger! Electric shock.

Danger! Risk of children suffocating when playing with the packaging. Keep the packaging out of the reach of children.



Warning! There is a risk of death, injury, fire, or damage to the equipment.

Warning! Turn off the electricity supply before carrying out any cleaning or maintenance work. Ensure that the power supply cannot be switched on accidentally.

Warning! Touching the appliance or plugs with wet hands may increase the risk of electric shock.

Warning! Despite an inherently safe design, the use of safety measures, and additional protective measures, there is always a residual risk of injury.

Warning! The furniture should not be used by people with physical disabilities that require them to maintain a fixed sitting position.

Warning! This product should be used for rest or relaxation.

Warning! This product does not meet the standards applicable to medical devices.

Warning! In the event of a malfunction or failure, stop using the device immediately, unplug it and contact an authorised distributor or manufacturer for repair!

Warning! Do not use the product if there is a risk of the upholstery fabric being torn or cut by moving parts underneath it

### **C. General safety rules**

- The device complies with the applicable technical standards and current safety requirements.
- Check if the mains voltage corresponds to the data on the rating plate on the product (appliance).
- The switching equipment must be installed in a fixed installation in accordance with the current wiring regulations.
- For safety reasons, only electrical accessories (power supply and power cables) with the appropriate specifications should be used.
- Check the furniture for any damage caused during transport.

- If the power cable is damaged, it must be replaced for safety reasons by the manufacturer, an authorised service centre, or another suitably qualified person.
- The plug must be connected to a socket of the appropriate type in accordance with current standards and in a location that is easily accessible.
- Adapters with multiple sockets should not be used.
- Protect the power/control cable and do not modify the electrical circuit.
- Do not use the product:
  - in the event of a defect or damage to the mains plug or power cable;
  - if the power supply is interrupted;
  - if the device is not working properly
- Before carrying out any cleaning or maintenance, the unit must be switched off or disconnected from the electricity supply.
- Do not expose the device to weather conditions.
- This manual contains important safety information that must be read and strictly adhered to.
- Furniture with an electric relaxation function should not be used with a load of more than 120 kg per seat and 40 kg per backrest.
- Do not sit on backrests, sides, or other items not designed for this.
- All electrical components used comply with current regulations.

#### **D. Installation**

- Remove all packaging material.
- Check the product for any damage caused during transport.
- Do not install or use a damaged device.
- Follow the installation instructions included with the device.
- Caution should be exercised when moving the unit as it is heavy. Always wear protective gloves and have full footwear on your feet.
- At least two people are required to assemble and set up the furniture.
- Install the unit in a suitable and safe location that meets the installation requirements.
- Maintain minimum distances from other appliances and furniture.
- The furniture must be placed on a flat and stable surface.
- Ensure that the power cable is not twisted or squashed.
- Do not place the power cable under heavy objects that may change the cable cross-section.
- Check whether the power cable lies freely at a safe distance from heat sources.

#### **E. Connection to the electric network**

- The electrical connection must be made in accordance with local regulations.
- All electrical connections should be made by a qualified electrician in accordance with current regulations.
- Never use a battery/power supply other than that supplied by the manufacturer.
- Ensure that the electrical connection information given on the nameplate matches the parameters of the supply system. If not, an electrician should be contacted.
- Always use correctly installed power sockets.
- Do not use splitters or extension leads.
- Ensure that the plug or power lead is not damaged.

- Have a damaged power cable replaced by the manufacturer, a service representative or a qualified electrician.
- For both live and insulated parts, the electric shock protection must be fixed in such a way that it cannot be disconnected without the use of tools.
- Ensure that the plug of the power lead is easily accessible once the appliance has been installed.
- If an electrical socket is loosened, do not connect the plug to it.
- When disconnecting the unit, do not pull on the power lead. Always pull the mains plug.

#### **F. Purpose**

- The device should be used in a domestic environment. It is important to protect the furniture from direct sunlight.
- Any irregularities that may occur (corrugations, dents) are transport-related and will fade with time. To speed up the process, we recommend carefully hand-fitting the upholstery and cover by shaping and smoothing the surface.
- Avoid extremes of temperature, humidity, fire and heat sources.
- Do not use the furniture in a dusty or dirty area. Ensure adequate ventilation and free space around the furniture.
- Do not change the technical parameters of the device.
- Avoid heavy loads at one point on the seat.
- Unplug the furniture during prolonged periods of disuse and before carrying out any cleaning, maintenance or repair work.

#### **G. Use**

- Do not use the appliance while other people (especially small children) and pets are around.
- Avoid sitting down with all the momentum.
- Once you have taken a position on the furniture, using the button on the control panel you can operate the actuator mechanism on the piece you wish to adjust and set.
- Once the desired sitting or lying position has been set, release the button on the control panel.
- Do not use the electrical functions of the furniture for too long continuously.
- Check the unit regularly for damage or signs of wear. In case of damage, turn off the power. Contact qualified personnel immediately to find the source the malfunction.
- Make sure that you always have easy access to the control panel and the power cord, plug or adapter to disconnect the device from the power source.
- Make sure that your body parts and the bodies of others never come close to the moving parts of the device while it is in use
- To avoid unannounced start-ups and unnecessary accidents, make sure that other people do not have direct access to the control panel.



**ATTENTION!!!** The actuators built into the furniture are not intended for continuous use! Do not press the buttons permanently, especially because of the risk of overheating.

**ATTENTION!!!** Observe the information given on the motor and power supply specifications. Information - Duty cycle: 2 min on/18 min off - this means that after 2 minutes of continuous operation, it should be interrupted for 18 minutes.

ATTENTION!!! On the specification, you will find technical data on the operating parameters: rated voltage, output voltage, and protection class on the transformer.

#### **H. Moving/transporting**

- In order to reposition the furniture, it should not be moved through the floor.
- To change the position of a furniture piece, it needs to be lifted and then moved to a new location.
- At least two people are required to lift the furniture.
- When lifting the piece of furniture, grab the stable parts - the base and the backrest (do not grab the sides, headrests, or other parts susceptible to damage)
- When moving furniture, disconnect the power/control cable first.
- When moving, take care not to damage cables and wires.

#### **I. Maintenance and cleaning**

- The furniture should be kept clean and dry with special protection and successive maintenance.
- Upholstered furniture and bed covers should be cleaned regularly as recommended. Proper maintenance and care will maintain the qualities for a long time.
- Before carrying out maintenance, switch off the unit and unplug the power cord from the electrical socket.
- Do not clean mechanical and electrical components with water, flammable cleaners, or other liquids.
- Never use a damp cloth to clean electrical parts (switch, socket, etc.).
- Before cleaning, test how the surface to be cleaned will react to the product by applying it to an invisible part of the furniture.
- During use, the furniture must be protected from harmful influences such as humidity, UV rays, excessive ambient temperature and over-drying, dust, sweat, grease, and household chemicals.
- The surface of the furniture should be protected from sharp objects.
- Do not disassemble or modify the mechanical and electrical components yourself
- Modification of mechanical and electrical components must only be carried out by a specialist or professional service.

#### **J. Overview of disruptions**

- Before working on the unit, switch off the electrical supply and ensure that the power cannot be switched on accidentally.
- Do not put your hands, fingers, or foreign bodies between the functional elements - especially when using the furniture, as this may cause injury or damage to the unit.
- If any faults or malfunctions are observed, the mechanism of the electric relaxation function should be stopped by releasing the control panel button.
- The sounds emitted during use and mechanical functions are a natural result of the construction, properties and specific characteristics of the materials used

#### **K. Utilisation**

- Disconnect the unit from the power source.
- Cut the power cord and discard it.

#### **L. Safety for children, heart pacemaker wearers, and people with limited motor, sensory or mental abilities**

- This appliance may be used by children over the age of eight and by persons with limited mental, physical and sensory abilities or insufficient experience and knowledge, if they are supervised by an adult or a person responsible for their safety.
- Children between the ages of 3 and 8 and people with severe disabilities should not approach the appliance unless they are under constant supervision.
- Children under 3 years of age should not approach the appliance unless they are under constant supervision.
- Children should not be left unsupervised and should not be allowed to play with the appliance and the fixed controls
- Keep all packaging out of the reach of children.
- Cleaning and maintenance must not be carried out by children without adult supervision.
- People with a pacemaker or other implanted electronic device should consult their doctor or the manufacturer of the device before using it.

If you have any concerns about your health, consult your doctor before using this product. People with heart pacemakers should not use this product. If you experience muscle or joint pain after prolonged use, discontinue the use and consult your doctor. Persistent pain may be a symptom of a more serious condition.

### **IV. Operation and use manual**

#### **A. Installation and use**



ATTENTION!!! The instructions for assembly and use may vary slightly depending on the model version.

ATTENTION!!! The shape of individual components may differ from that shown in the instructions.

#### **Step 1:**

Remove the furniture components carefully from the packaging. Temporarily lay (horizontally!) the elements in a safe place.

Advice: Carefully remove the packaged components using a knife or scissors; take care not to damage them!

#### **Step 2:**

Unpack the fittings from the packaging. Temporarily lay (horizontally!) the elements in a safe place.

#### **Step 3:**

Remove all safety features as instructed.

#### **Step 4:**

Two people are required for installation.

For installation you will need:

- cross-head screwdriver
- flathead screwdriver;
- spanner 6, 8, 10;

Connect all the furniture components according to the instructions. Ensure that the upholstery hooks have come together, all components are fitted and screwed together and the surfaces are at one level.

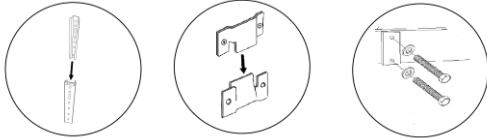

**Step 5:**

Position the furniture to be at a sufficient distance from the energy source. Maintain minimum distances from other appliances and furniture.

**Step 6:**

Connect the power supply and then the power cable to the plug protruding from the back of the furniture at the appropriate point. Plug the complete unit into a power socket.

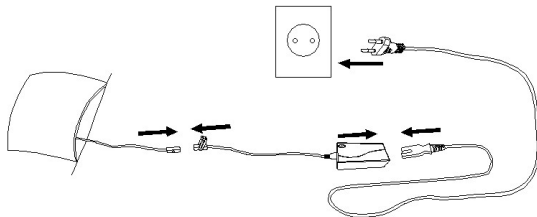

Ensure that the electrical connection information given on the nameplate matches the parameters of the supply system. If not, an electrician should be contacted. Ensure that the power cable is not twisted or squashed.

**Step 7:**

To start using the electric relaxation/sleep function, the correct position must be taken.

**Step 8:**

Using the relax/sleep function  
Control panel (pilot)

	Back suport up
	Back suport down
	Back suport and legs up
	Back suport and legs down
	Legs suport up
	Legs suport down



Lifting the relax function of the headrest/footboard - Hold the button down until the headrest/footboard lifts and reaches the correct position and then release the button. The headrest/footboard will remain in the selected position.

Lowering the relaxed headrest/footboard function - Hold down the button until the headrest/footboard lowers to the selected position and then release the button. The headrest/footboard will remain in the selected position.

### B. Problem-solving

Problem	Possible cause	Solution
The device does not work.	No electrical supply.	Check whether electrical power is available. Switch the appliance off and on again to check whether the fault persists.
	The appliance is not connected to the electricity supply.	Check whether the appliance is connected to the electricity supply. Switch the appliance off and on again to check whether the fault persists.
	Improperly assembled components	Check the installation according to the manufacturer's information in the installation instructions
	Motor/power supply failure	Contact the manufacturer or an authorised service centre
	Broken power cable	Check the connection, contact the manufacturer or an authorised service centre
Relax/sleep function does not slide out	Cracked/broken frame parts	Contact the manufacturer or an authorised service centre
The device hums or operates erratically	Exceeded temperature	Ensure better ventilation and heat dissipation,
	Overheating and overloading	The appliance has been operated for longer than the recommendations indicate. Unplug them from the power source and wait until they have cooled down completely.

Before contacting the technical service or the manufacturer:

Restart the unit to check whether the fault persists. If not, it will switch the device off and then back on again after one hour.





If, after switching the appliance back on and following the steps described in the fault-finding instructions, the appliance is still not functioning correctly, contact an authorised service centre, explain the problem and state:

- type of fault;
- furniture model;
- production type and serial number

### C. Environmental aspects

The packaging is made of environmentally friendly and recyclable materials.

- Outer packaging made of cardboard
- Części wyprofilowane z pianki polistyrenowej (PS) nie zawierającej freonu
- Polyethylene (PE) films and bags
- Fastening tapes made of polypropylene (PP)

	<p>The object of the declaration described above is in conformity with the relevant Community legislation  Machinery Directive 2006/42/EU,  EMC Electromagnetic Compatibility Directive 2014/30/EU,  LVD Low Voltage Directive 2014/35/EU,  RoHS Directive 2011/65/EU,</p>
 	<p>Directive 2012/19/EU of the European Parliament and of the Council (WEEE Directive): In the European Union, products marked with this symbol may not be disposed of with municipal waste. For proper recycling of this product, return it to your local supplier at the time of purchase of equivalent new equipment or dispose of it at designated collection points.  - Proper disposal and scrapping help to eliminate the adverse impact of scrap products on the environment and human health.</p>
	<p>Materials with the symbol are recyclable. Dispose of packaging items in appropriate containers, observing local waste disposal regulations.</p>

**This declaration of conformity is issued under the sole responsibility of the manufacturer**